



## Cowa COMPACT Cell DHW









The most compact thermal storage for efficient domestic hot water preparation in modern heating systems.

Thanks to Cowa's thermal storage technology based on phase change materials (PCM), cold water is heated on demand using the tankless principle, enabling a design up to five times more compact than conventional hot water storage tanks.

### Product Features:

- ✓ **Space-saving design** – Only 600 mm x 340 mm x 1400 mm
- ✓ **Efficient hot water supply** – Tapping volume of up to 400 liters
- ✓ **High storage capacity** – Up to 13 kWh of thermal energy
- ✓ **Energy efficient** – Minimal heat loss, high efficiency
- ✓ **Optimized for heat pumps** – Perfect match with modern heating systems
- ✓ **Hygienic & safe** – No stagnant water, no risk of Legionella
- ✓ **High performance** – 25 L/min flow rate



-  Most compact thermal heat storage
-  Fresh water systems / hygienic storage tanks
-  Use with heat pumps
-  Compact gas replacement
-  Internal building circulation
-  Self-consumption optimization
-  Integration into district heating systems
-  Peak load management

### Key Features:

- Stratification-free
- Temperature stability
- Physical separation of primary & secondary circuit
- Integrated high-performance dual heat exchanger
- Cubic design for optimal space utilization

<b>COMPACT Cell DHW</b>		<b>48</b>	<b>58</b>
Height	mm	1400	1400
Width	mm	600	600
Depth	mm	340	340
Weight	kg	262	250
Nominal storage capacity <sup>1</sup> charged to 55°C/65°C	kWh	10 / 12	- / 12.5
Nominal draw-off volume <sup>1</sup> V <sub>40</sub> charged to 55°C/65°C	L	310/370	- / 400
Discharge temperature	°C	45	55
Energy label <sup>2</sup>		B	B
Possible water flow rate	L/min	25	25
Pressure drop at max. flow rate	kPa	48	48
Minimum operating pressure	bar	1.5	1.5
Maximum operating pressure	bar	6	6
Maximum operating temperature	°C	75	75
Compatible heat pumps		Standard HP	R290, R454C
Min. supply temperature	°C	57	65
Min. return temperature	°C	52	60

[1] Tap water temperature = 40 °C, cold water temperature = 10 °C, storage temperature = 55 °C or 65 °C, at a tap flow rate of 10L/min.

[2] Calculated at an average storage temperature of 60 °C and an ambient temperature of 15 °C.

## Dimensions & Connections

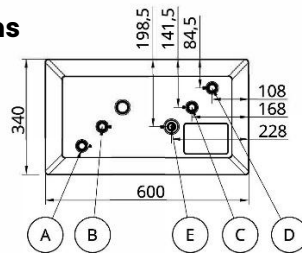

Supply line of charging circuit	A	22mm
Domestic hot water outlet	B	22mm
Cold water inlet	C	22mm
Return line of charging circuit	D	22mm
Temperature sensor port	E	∅ 6mm

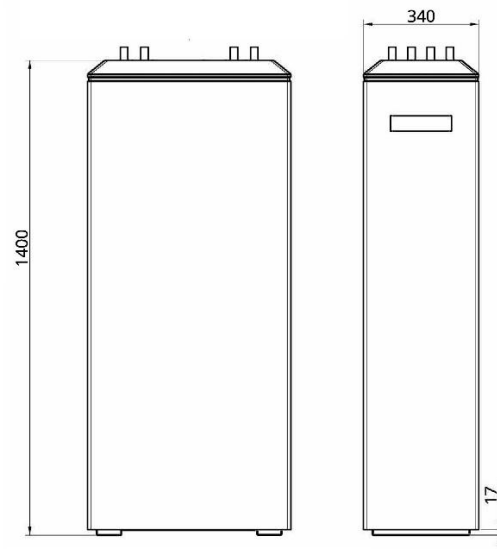

## Hydronic integration into the heating system

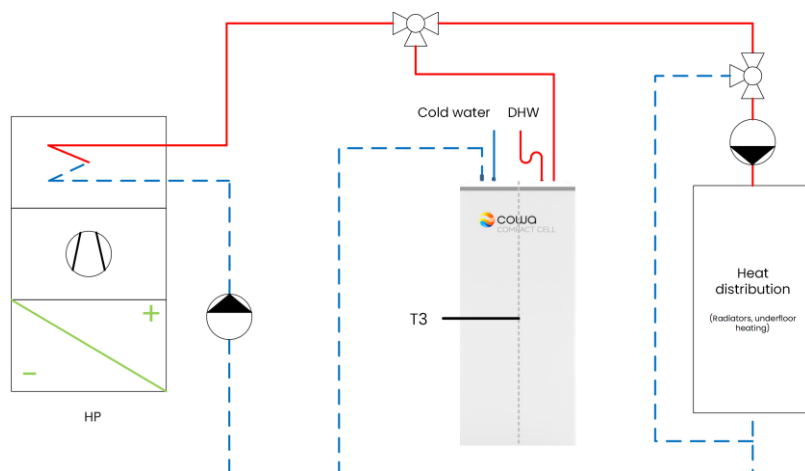

The Cowa COMPACT Cell can be modularly expanded to achieve the desired capacity.

For further information on application and integration, please refer to the installation and operating manual.